

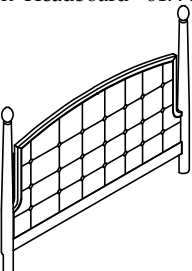

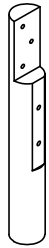







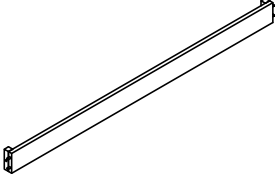

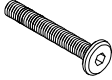

Warning:

- Be sure to check all packing material carefully for small parts, which may have come loose inside the carton during shipment.
- To prevent possible scratches and damage, this furniture **MUST BE ASSEMBLED BY TWO PEOPLE** on a soft surface such as a blanket or carpet.



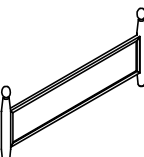
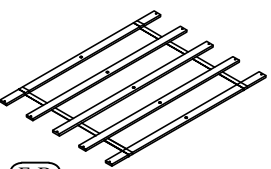

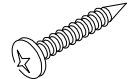

Hardware and Parts packed with the Headboard

<p>Queen Uph Headboard - 61770</p>  <p>(H-A) 1 pc.</p>	<p>Headboard Post (Left)</p>  <p>(H-B) 1 pc.</p>	<p>Headboard Post (Right)</p>  <p>(H-C) 1 pc.</p>	<p>Headboard Stretcher</p>  <p>(H-D) 1 pc.</p>			
<p>Allen Head Bolt Ø5/16" - 18 x 1-9/16"</p>  <p>(H-E) 6 pcs.</p>	<p>Spring Washer Ø5/16"</p>  <p>(H-F) 6 pcs.</p>	<p>Flat Washer Ø5/16" x Ø19mm</p>  <p>(H-G) 6 pcs.</p>	<p>Allen Head Bolt Ø1/4" - 20 x 2"</p>  <p>(H-H) 2 pcs.</p>	<p>Spring Washer Ø1/4"</p>  <p>(H-I) 2 pcs.</p>	<p>Flat Washer Ø1/4" x Ø16mm</p>  <p>(H-J) 2 pcs.</p>	<p>Allen key 4mm</p>  <p>(H-K) 1 pc.</p>

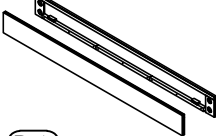
Hardware and Parts packed with the Footboard

<p>Queen Panel Footboard - 61771</p>  <p>(F-A) 1 pc.</p>	<p>Wood Slats (61-7/16" long)</p>  <p>(F-B) 5 pcs.</p>	<p>Support leg (9-7/16" x 1-1/4" x 1-1/4")</p>  <p>(F-C) 5 pcs.</p>	<p>Wood Screw Ø4 x 30 (mm)</p>  <p>(F-D) 10 pcs.</p>	<p>Screw Driver (not included)</p> 
---------------------------------------------------------------------------------------------------------------------------------------------	-------------------------------------------------------------------------------------------------------------------------------------------	------------------------------------------------------------------------------------------------------------------------------------------------------------	-----------------------------------------------------------------------------------------------------------------------------------------------	------------------------------------------------------------------------------------------------------------------------------

Hardware and Parts packed with the Bed Rails

<p>Queen-King Side Rails - 61772</p>  <p>(R-A) 2 pcs.</p>	<p>Curved Washer Ø5/16"</p>  <p>(R-B) 8 pcs.</p>	<p>Spring Washer Ø5/16"</p>  <p>(R-C) 8 pcs.</p>	<p>Hex Nut Ø5/16" x 17mm</p>  <p>(R-D) 8 pcs.</p>	<p>All-Thread Bolt Ø5/16" - 18 x 3-1/8"</p>  <p>(R-E) 8 pcs.</p>	<p>Open Wrench 12 mm</p>  <p>(R-F) 1 pc.</p>
---------------------------------------------------------------------------------------------------------------------------------------------	-----------------------------------------------------------------------------------------------------------------------------------------	-----------------------------------------------------------------------------------------------------------------------------------------	------------------------------------------------------------------------------------------------------------------------------------------	-----------------------------------------------------------------------------------------------------------------------------------------------------------	---------------------------------------------------------------------------------------------------------------------------------------

Queen Uph Bed

- 61770 -- Queen Uph Headboard
- 61771 -- Queen Panel Footboard
- 61772 -- Queen-King Side Rails

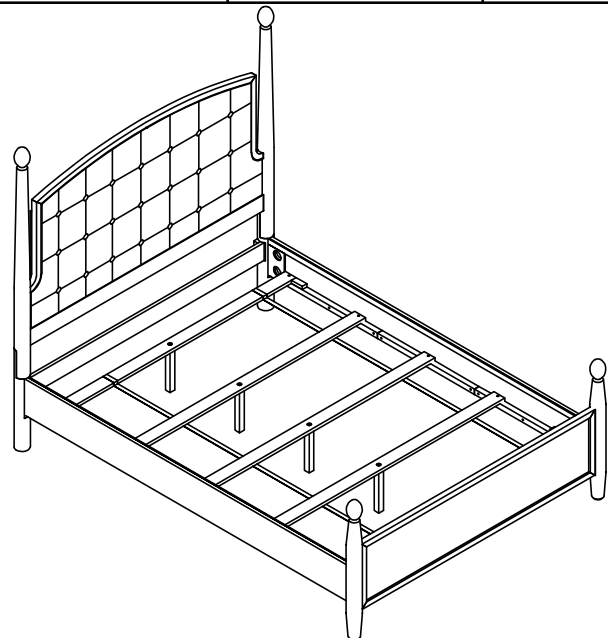

Queen Uph Bed
61770 -- Queen Uph Headboard

Step 1

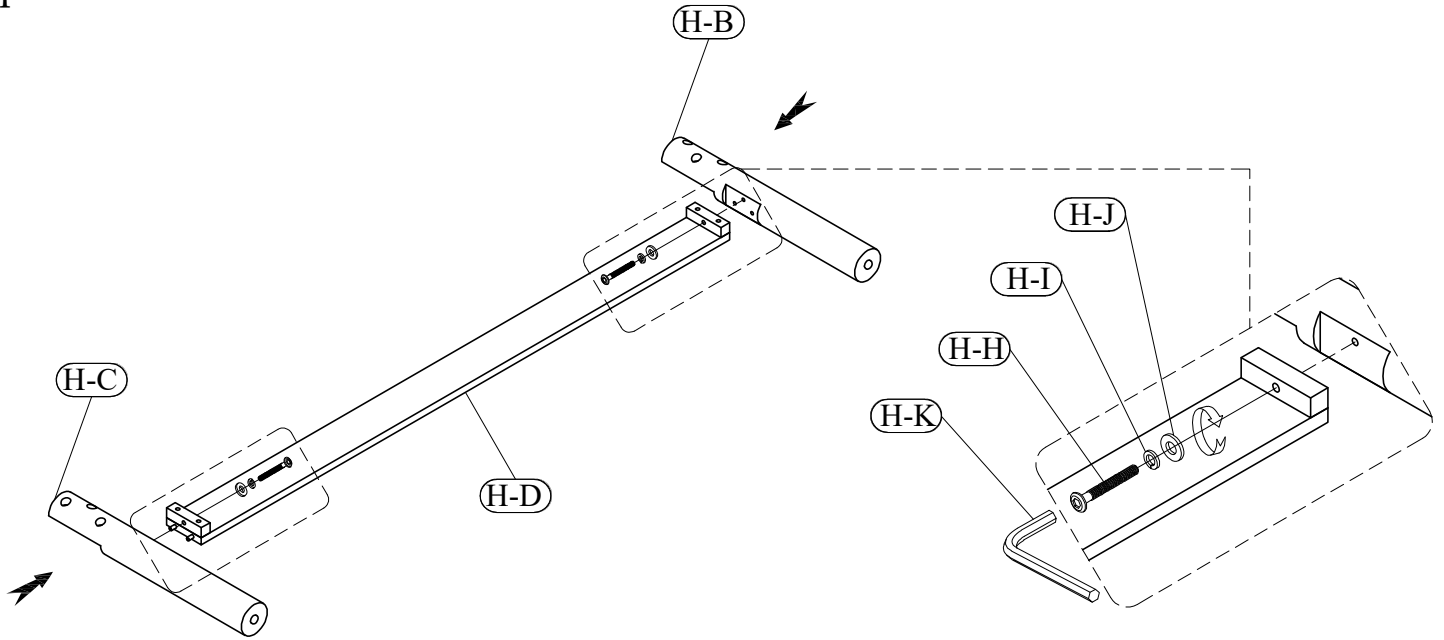

Step 2

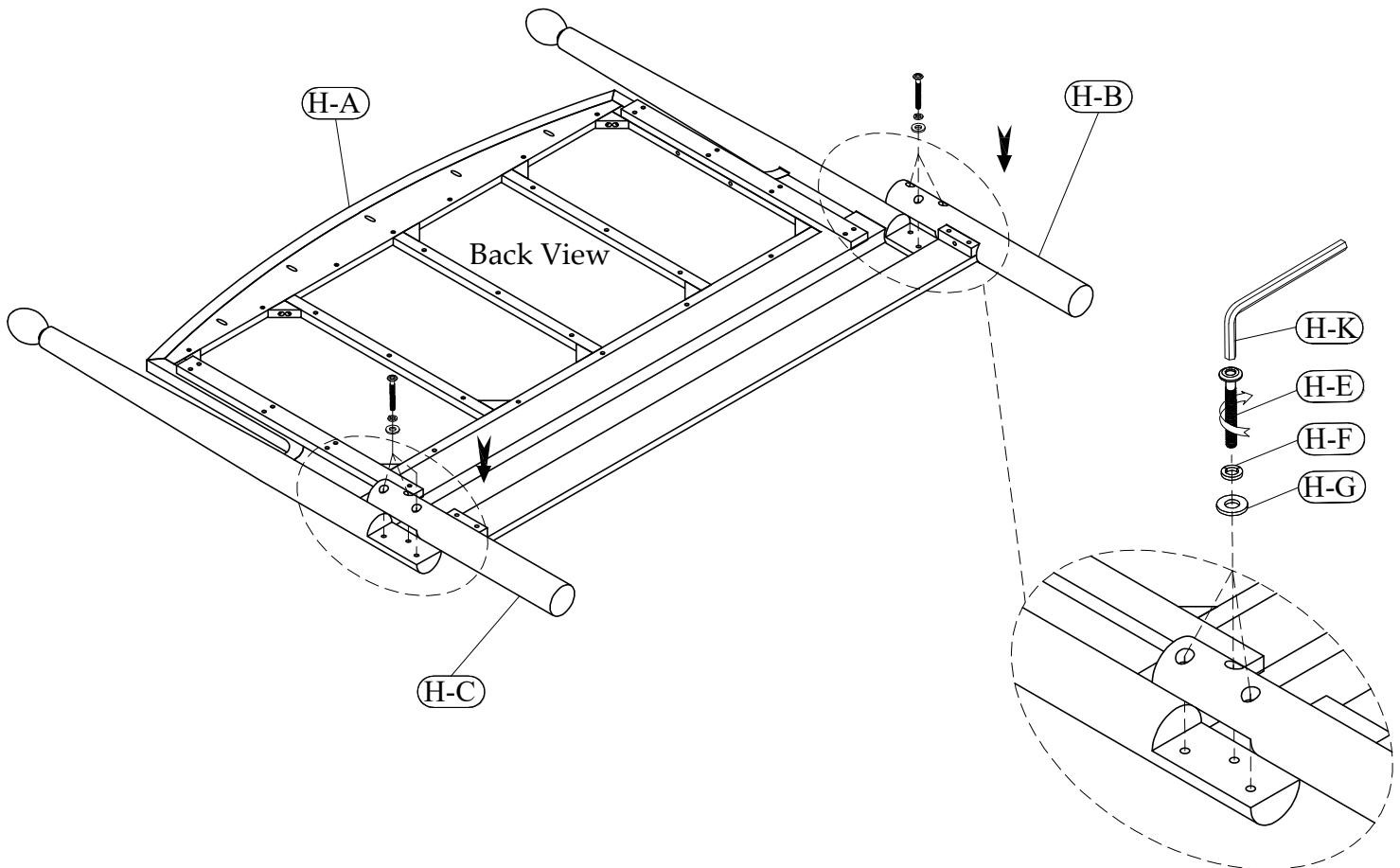

Queen Uph Bed

61770 -- Queen Uph Headboard

61771 -- Queen Panel Footboard

Step 3

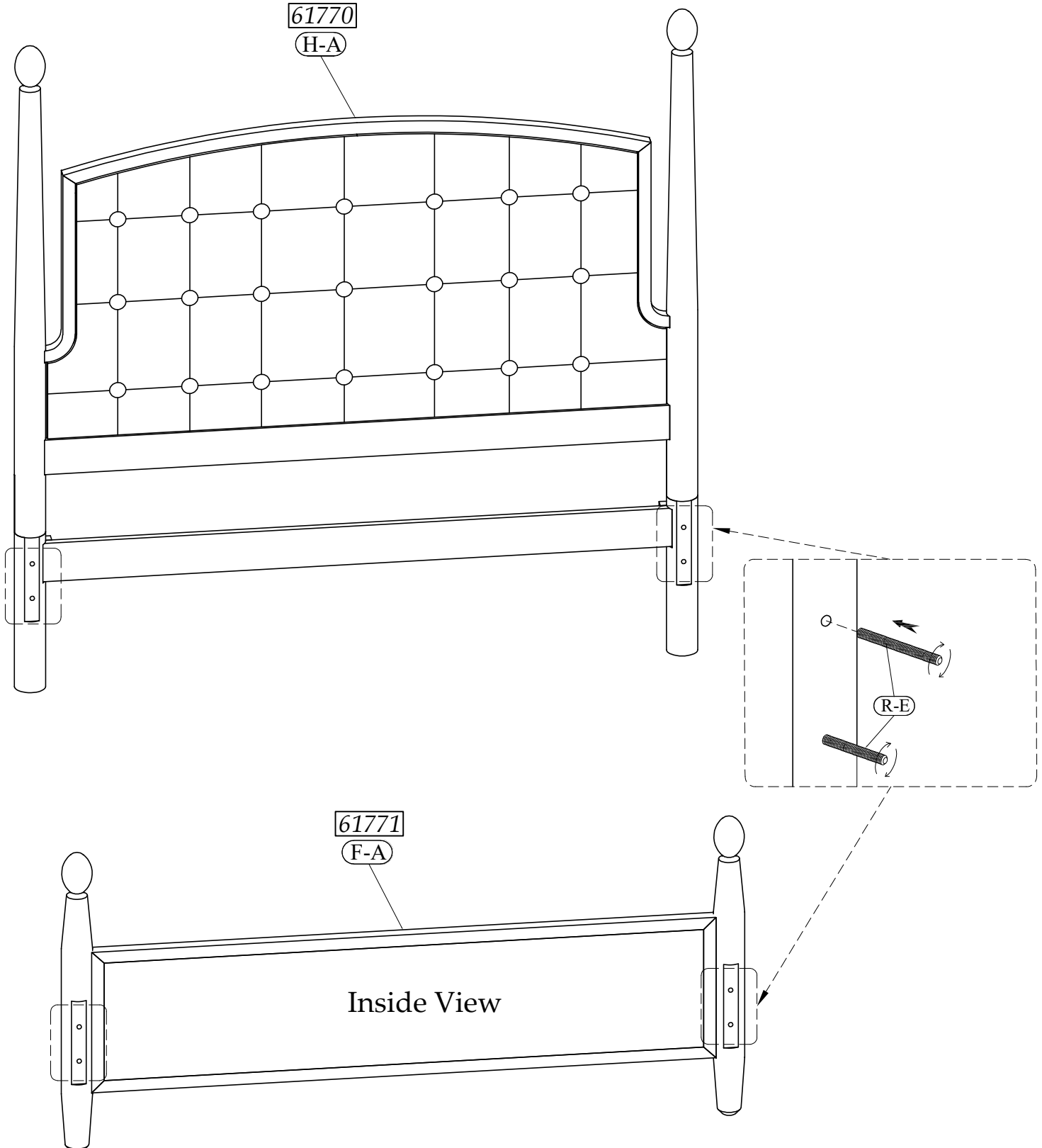

Queen Uph Bed

61770 -- Queen Uph Headboard

61771 -- Queen Panel Footboard

61772 -- Queen-King Side Rails

Step 4

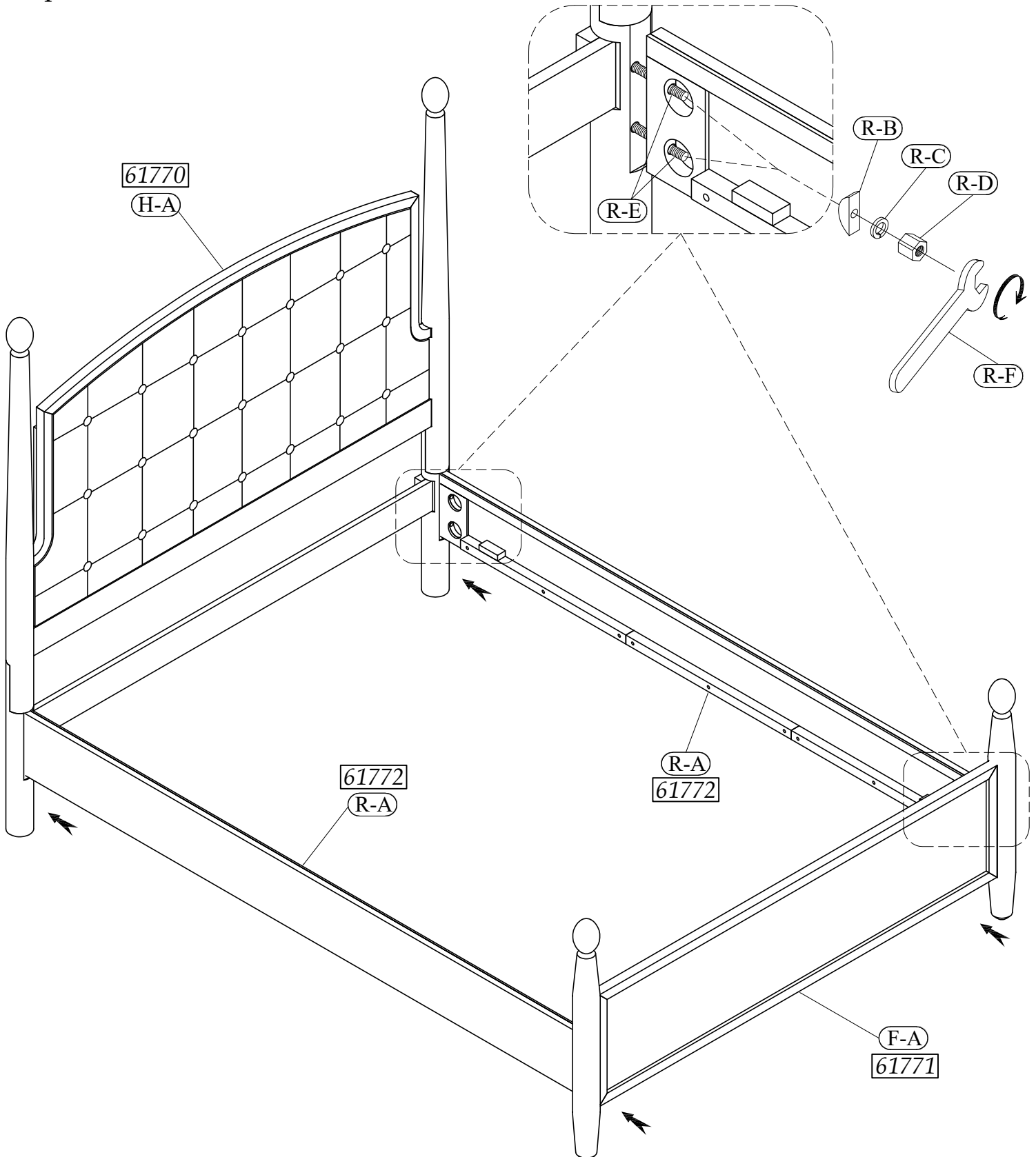

Step 5

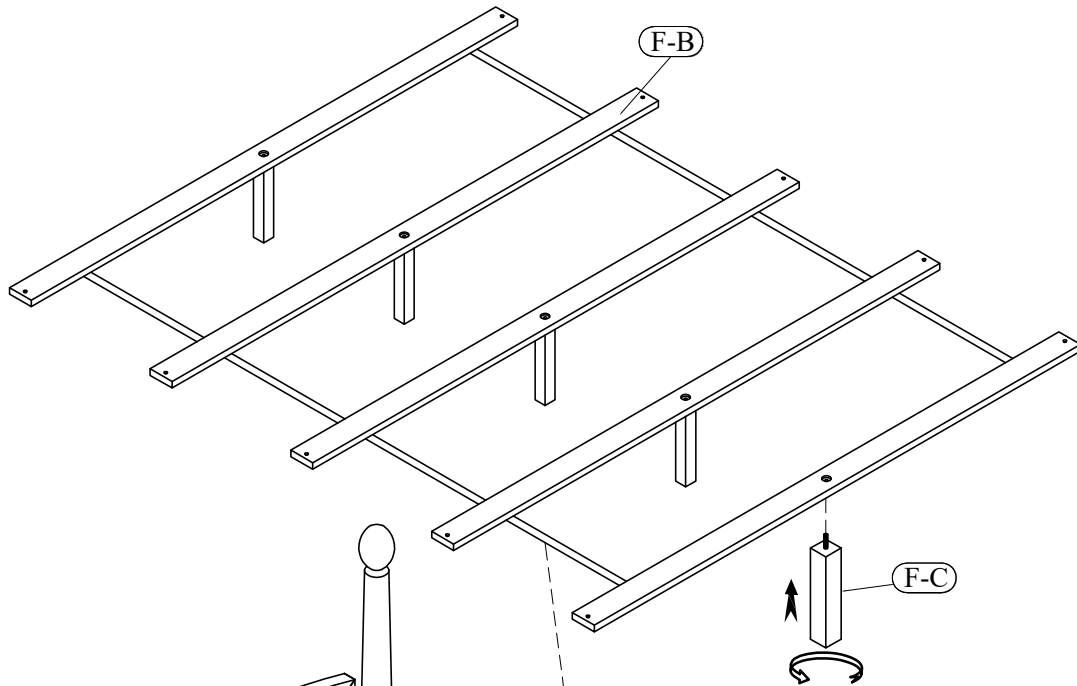

Step 6

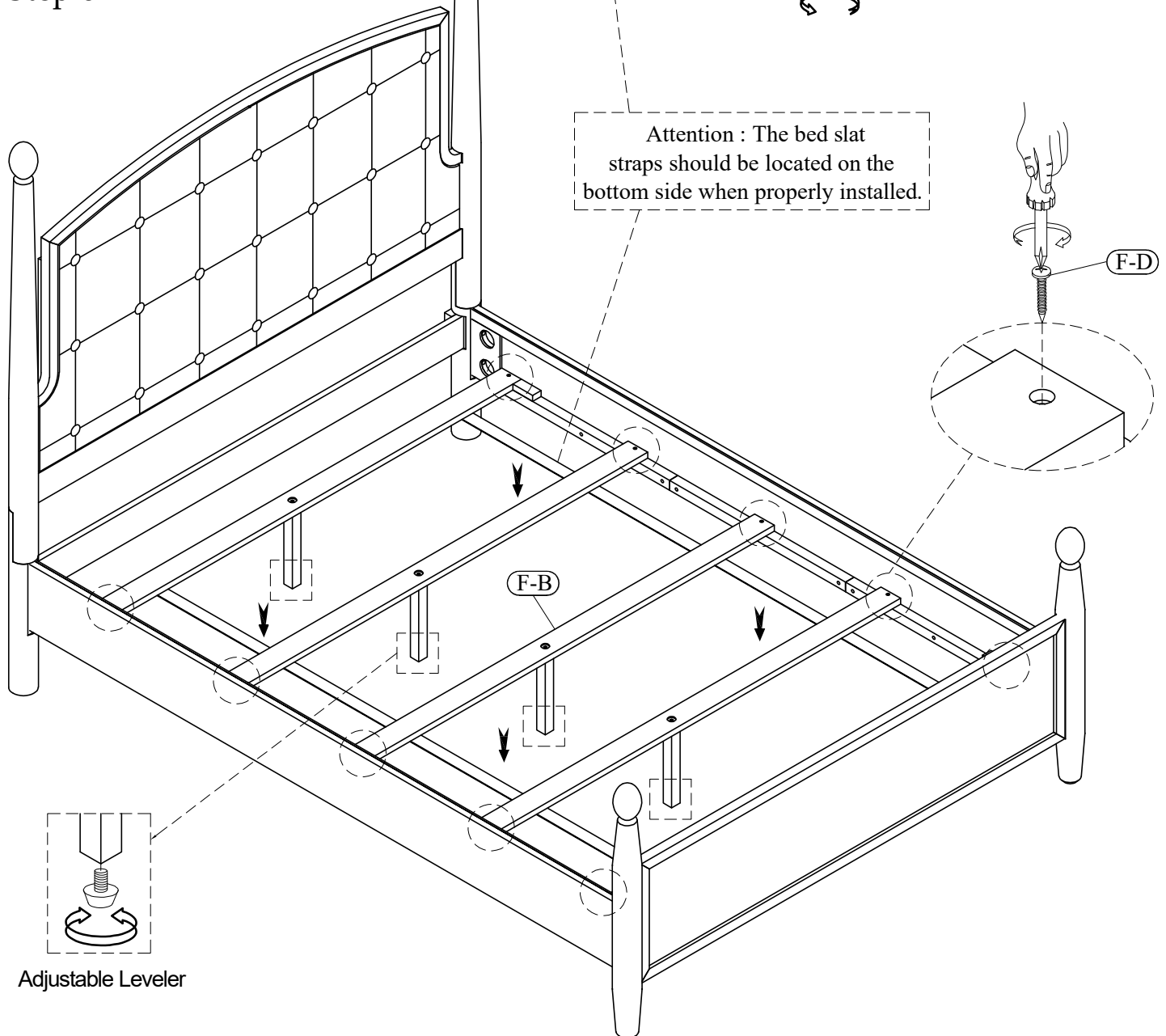

Attention : The bed slat straps should be located on the bottom side when properly installed.

Adjustable Leveler